

Pressure regulators series ALFA

ALFA series regulators are direct action spring controlled and are made to operate on gas plants of the first, second and third family and with all not corrosive gases.

They can also be supplied in special execution for biogas, oxygen and ammonia, and whenever required they can have a safety shutoff valve for maximum and minimum pressure.

The simple construction, quick response and high working reliability make ALFA regulators particularly suitable for sudden variation of flow rate together with upstream pressure variation.

For these reasons they can be installed in any industrial and domestic gas plants.

All the regulators are manufactured according to CE and PED standards certification and have H-H1 total quality insurance.



TECHNICAL FEATURES

Body material	Cast iron GS400
Top cover material	Die-casted aluminium
Sealing material	Seal nitrile rubber NBR o HNBR
Diaphragm material	Rubberized canvas
Connections	Thread according EN 10226 and flanged PN16 according ISO 7005
Working temperature	-20 + 60 °C

FEATURES

- Wide range of downstream pressure springs
- Downstream spring setting according to specific requirement
- On-field regulation of the required pressure
- Shut-off valve integrated within the body of the pressure regulator
- Anti pumping device available on request to avoid malfunctioning due to sudden pressure variations
- Minimum flow rate must not be lower than 10% of the max flow rate

ALFA 10 - 1" x 1"

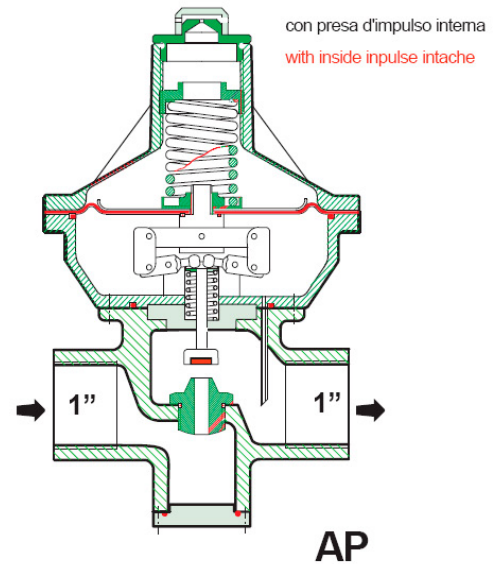
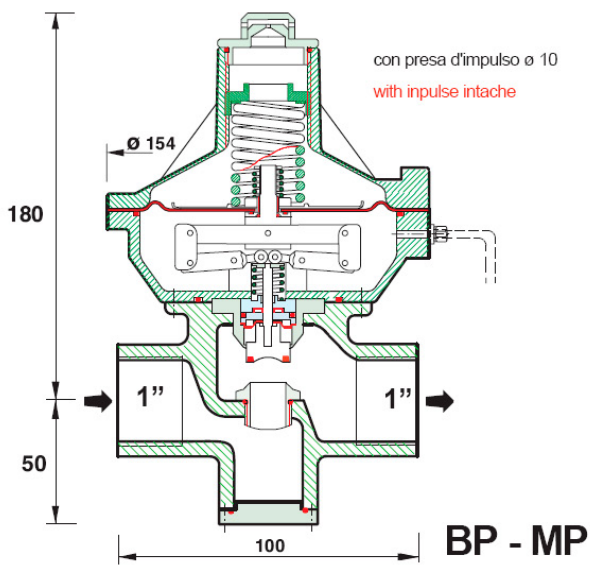

NATURAL GAS FLOW RATE ALFA 10 in m³/h

Down stream press. - mbar -	Low pressure BP - inlet (bar)							
	0,2	0,3	0,5	1	1,5	2	3	4 - 5
25	33	41	55	82	104	126	168	209
35	32	40	54	81	104	126	168	209
50	30	39	53	80	103	125	168	209
100	23	36	51	79	103	125	168	209

Down stream press. - bar -	Medium pressure MP - inlet (bar)					
	0,3	0,5	1	1,5	2	3 - 5
0,11	63	91	141	183	223	249
0,15	57	87	139	182	222	258
0,20	47	82	138	181	222	269
0,30	-	70	133	179	220	291

Down stream press. - bar -	High pressure AP - inlet (bar)							
	2	3	4	5	8	10	12	16 - 18
0,35	127	172	215	258	302	302	302	302
0,5	125	171	215	258	336	336	336	336
0,7	121	170	215	258	381	381	381	381
1	113	167	213	258	387	448	448	448
1,5	89	156	208	255	388	473	557	560
2	-	138	199	250	387	474	559	673

ALFA 20 - 1" x 1.1/2"

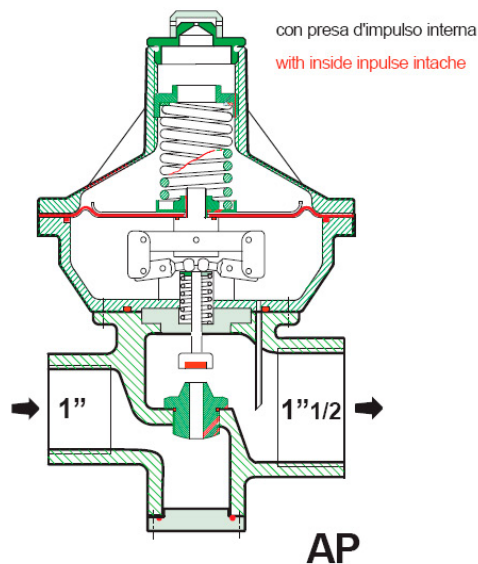
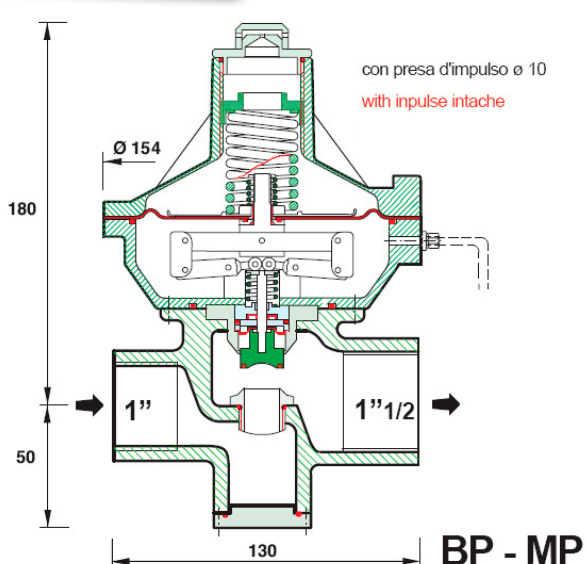

NATURAL GAS FLOW RATE ALFA 20 in m³/h

Down stream press. - mbar -	Low pressure BP - inlet (bar)								
	0,2	0,3	0,5	1	1,5	2	3	4	5
25	43	54	72	106	136	165	220	275	328
35	42	53	71	106	136	165	220	275	328
50	40	52	70	105	136	165	220	275	328
100	33	47	67	104	135	165	220	275	329

Down stream press. - bar -	Medium pressure MP - inlet (bar)							
	0,3	0,5	1	1,5	2	3	4	5
0,11	86	152	193	250	304	408	508	576
0,15	78	146	191	249	304	408	508	597
0,20	65	138	188	248	303	408	508	609
0,30	-	96	182	245	301	407	509	610

Down stream press. - bar -	High pressure AP - inlet (bar)								
	2	3	4	5	8	10	12	16	18
0,35	139	189	236	283	421	512	604	701	701
0,5	137	188	236	283	422	514	605	779	779
0,7	133	186	236	284	423	515	606	883	883
1	124	183	234	283	424	517	609	948	1039
1,5	97	172	229	280	426	519	612	953	1062
2	-	151	218	274	425	520	614	957	1067

ALFA 30 - 31 - 35 1"x1.1/2"

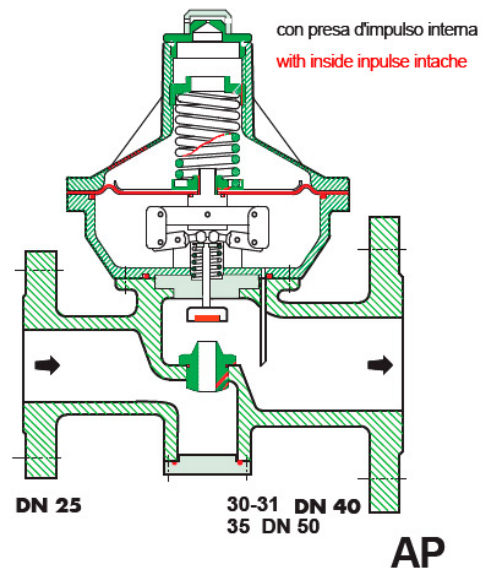
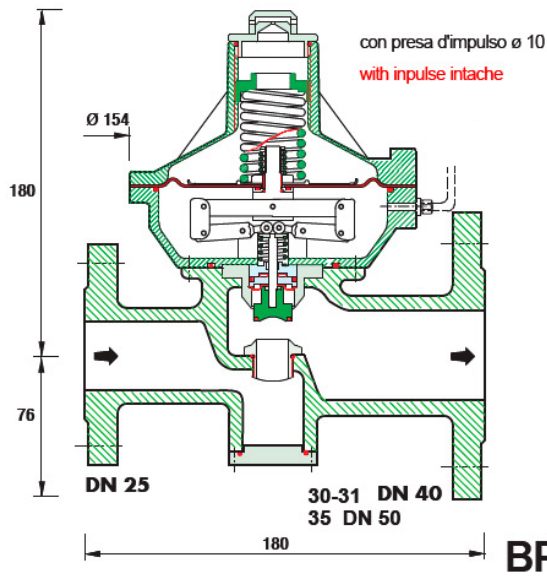

NATURAL GAS FLOW RATE ALFA 30 - 31 - 35 in m³/h

Down stream press. - mbar -	Low pressure BP - inlet (bar)								
	0,2	0,3	0,5	1	1,5	2	3	4	5
25	47	59	78	116	149	181	241	301	360
35	46	58	78	116	149	181	241	301	360
50	44	57	77	116	149	181	241	301	360
100	37	52	74	114	148	180	241	301	360

Down stream press. - bar -	Medium pressure MP - inlet (bar)							
	0,3	0,5	1	1,5	2	3	4	5
0,11	93	133	207	269	326	437	545	652
0,15	84	128	205	267	326	437	545	652
0,20	70	121	202	266	325	437	546	653
0,30	-	103	195	262	323	437	546	654

Down stream press. - bar -	High pressure AP - inlet (bar)						
	2	3	4	5	8	10	12 - 18
0,35	333	451	565	676	916	916	916
0,5	328	450	565	677	1009	1047	1047
0,7	319	446	564	678	1011	1153	1153
1	298	437	560	677	1015	1235	1357
1,5	293	411	547	671	1017	1241	1462
2	-	363	522	656	1016	1243	1467

ALFA 40 DN40 X DN40

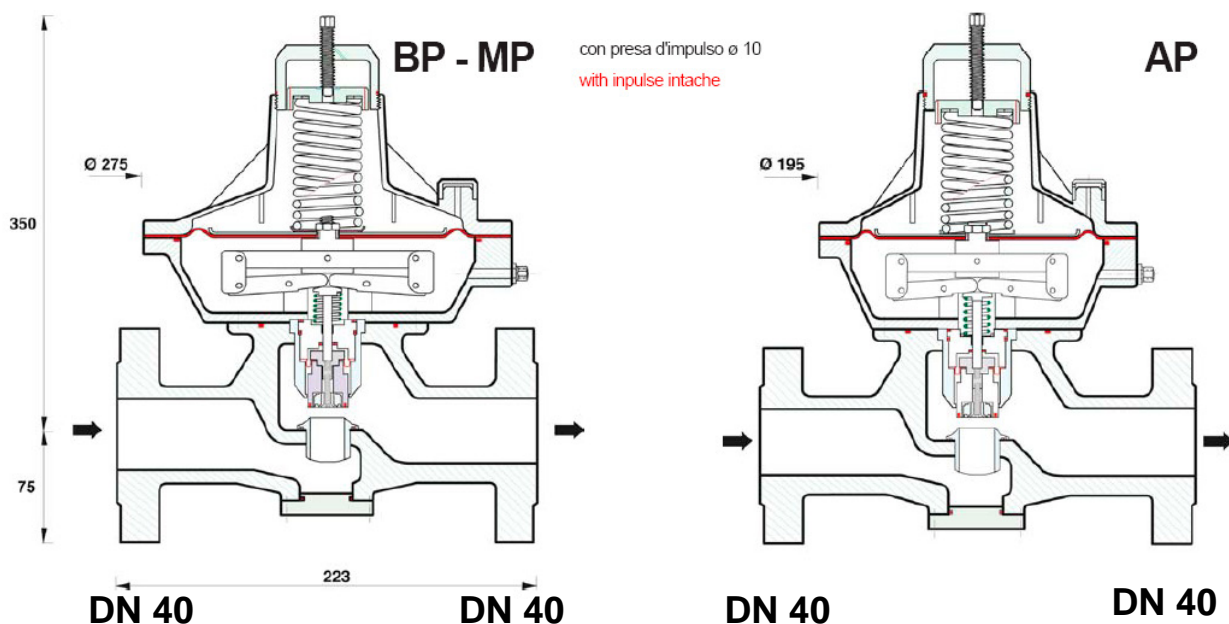

NATURAL GAS FLOW RATE ALFA 40 in m³/h

Down stream press. - mbar -	Low pressure BP - inlet (bar)								
	0,2	0,3	0,5	1	1,5	2	3	4	5 - 8
25	131	165	184	286	403	484	672	695	695
35	128	164	168	276	399	479	672	702	702
50	123	164	218	324	405	503	672	712	712
100	103	163	217	323	404	502	673	746	746
120	93	139	203	317	413	502	673	760	760

Down stream press. - bar -	Medium pressure MP - inlet (bar)							
	0,3	0,5	1	1,5	2	3	4	5 - 8
0,11	146	207	319	414	502	673	753	753
0,15	129	197	315	412	502	673	780	780
0,20	108	186	311	409	500	673	814	814
0,30	-	158	300	404	497	672	841	882

Down stream press. - bar -	High pressure AP - inlet (bar)						
	2	3	4	5	8	10	12 - 18
0,5	488	670	841	1009	1017	1017	1017
1	444	651	834	1008	1357	1357	1017
1,5	348	611	814	998	1514	1696	1696
2	-	540	777	977	1513	1851	2035
3	-	-	622	888	1489	1844	2714
4	-	-	-	696	1433	1816	2861

ALFA 50 DN50 X DN50

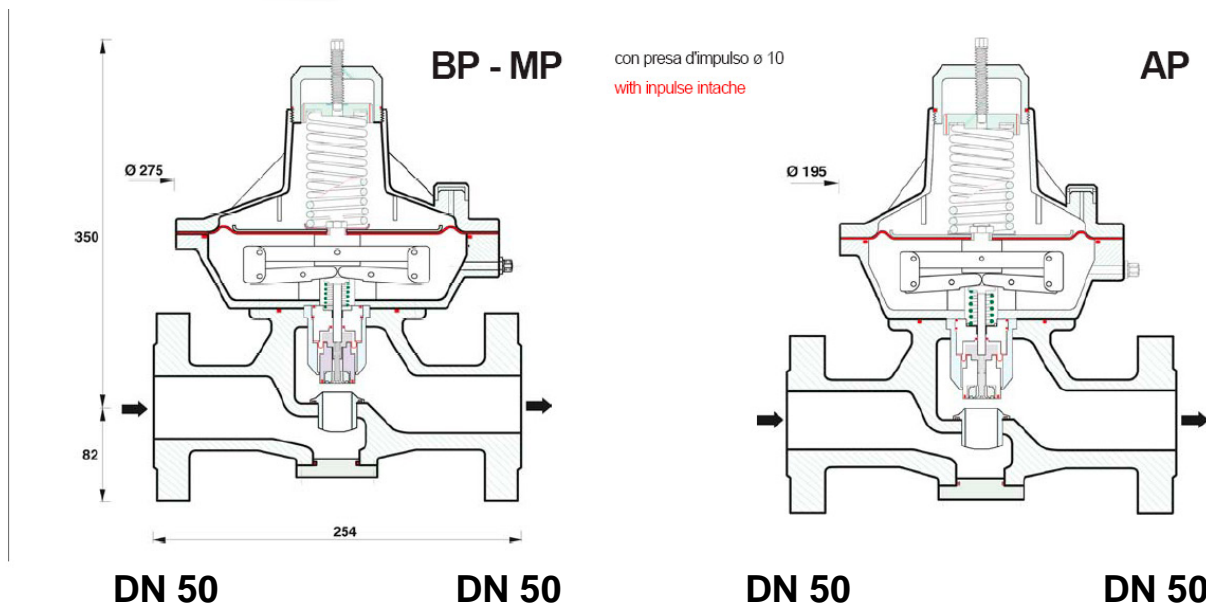













NATURAL GAS FLOW RATE ALFA 50 in m³/h

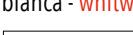





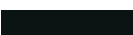





Down stream press. - mbar -	Low pressure BP - inlet (bar)							
	0,2	0,3	0,5	1	1,5	2	3	4 - 8
25	206	258	287	448	630	756	1051	1086
35	201	256	263	431	623	748	1051	1097
50	193	255	341	506	633	787	1051	1113
100	161	254	339	505	632	785	1051	1166
120	146	218	318	496	646	785	1051	1187

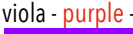

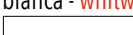







Down stream press. - bar -	Medium pressure MP - inlet (bar)						
	0,3	0,5	1	1,5	2	3	4 - 8
0,11	228	323	499	647	785	1051	1176
0,15	202	308	492	644	784	1051	1219
0,20	168	291	485	640	782	1051	1272
0,30	-	248	469	631	777	1051	1378

Down stream press. - bar -	High pressure AP - inlet (bar)						
	2	3	4	5	8	10	12 - 18
0,5	763	1046	1314	1576	1590	1590	1590
1	694	1018	1304	1576	2120	2120	2120
1,5	543	956	1272	1560	2366	2650	2650
2	-	844	1214	1527	2364	2892	3180
3	-	-	973	1388	2337	2882	3418
4	-	-	-	1087	2240	2838	3498

SPRINGS OF DOWNSTREAM PRESSURE

ALFA	BASSA PRESSIONE Low pressure Basse pression	MEDIA PRESSIONE Medium pressure Moyenne pression	ALTA PRESSIONE High pressure Haute pression
10	oro - gold Ø 1,6  16 ÷ 26 mbar	blu - blue - bleu Ø 2,5  95 ÷ 130 mbar	viola - purple - violet Ø 3,5  0,29 ÷ 0,44 bar
	azzurro - light blue - bleu clair Ø 1,8  22 ÷ 32 mbar	arancione - orange - orange Ø 3  130 ÷ 220 mbar	bianca - whitw - blanc Ø 4  0,38 ÷ 0,6 bar
	rossa - red - rouge Ø 2  30 ÷ 43 mbar	marrone - brown - marron Ø 3,5  200 ÷ 300 mbar	verde - green - vert Ø 4,5  0,56 ÷ 0,88 bar
20	gialla - yellow - jaune Ø 2,2  42 ÷ 72 mbar	viola - purple - violet Ø 3,5  260 ÷ 450 mbar	nera - black - noir Ø 5  0,8 ÷ 1,3 bar
	blu - blue - bleu Ø 2,5  70 ÷ 110 mbar		grigia - grey - gris Ø 5,5  1 ÷ 2,1 bar

30 - 35	oro - gold Ø 1,6  16 ÷ 26 mbar	blu - blue - bleu Ø 2,5  95 ÷ 130 mbar	marrone - brown - marron Ø 3,5  0,29 ÷ 0,4 bar
	azzurro - light blue - bleu clair Ø 1,8  22 ÷ 32 mbar	arancione - orange - orange Ø 3  130 ÷ 220 mbar	viola - purple - violet Ø 3,5  0,37 ÷ 0,58 bar
	rossa - red - rouge Ø 2  30 ÷ 43 mbar	marrone - brown - marron Ø 3,5  200 ÷ 300 mbar	bianca - whitw - blanc Ø 4  0,45 ÷ 0,71 bar
31 - 35 AP	gialla - yellow - jaune Ø 2,2  42 ÷ 72 mbar	viola - purple - violet Ø 3,5  260 ÷ 450 mbar	verde - green - vert Ø 4,5  0,69 ÷ 1 bar
	blu - blue - bleu Ø 2,5  70 ÷ 110 mbar		nera - black - noir Ø 5  1 ÷ 1,5 bar
			grigia - grey - gris Ø 5,5  1,4 ÷ 2,1 bar

40	blu - blue - bleu Ø 3,5  23 ÷ 30 mbar		bianca - white - blanc Ø 7  0,3 ÷ 0,75 bar
	arancione - orange - orange Ø 4  28 ÷ 42 mbar	bianca - white - blanc Ø 7  110 ÷ 320 mbar	verde - green - vert Ø 4  0,58 ÷ 0,9 bar
50	azzurro - light blue - bleu clair Ø 3,5  45 ÷ 90 mbar		nera - black - noir Ø 4,5  0,85 ÷ 1,25 bar
	marrone - brown - marron Ø 3,5  75 ÷ 120 mbar		grigia - grey - gris Ø 5  1,1 ÷ 2 bar
			viola - purple - violet Ø 5,5  1,85 ÷ 4 bar

SHUT-OFF VALVE FOR MINIMUM AND MAXIMUM PRESSURE

All pressure regulators Alfa can be supplied complete with shut-off valve for minimum and maximum pressure. The shut-off valve is mounted directly on the bottom of the pressure regulator body valve; in order to select the model of the shut-off valve and the spring, check the tables here aside:

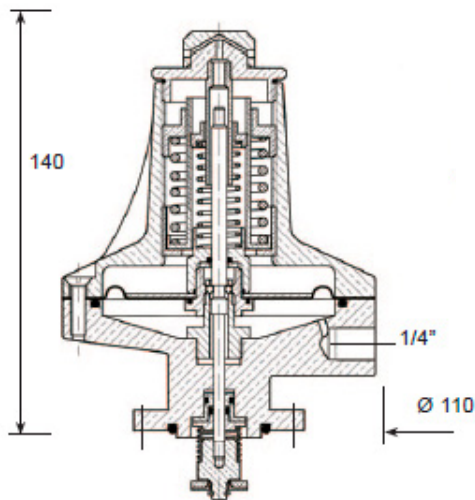

Pressure regulator		Shut-off valve
ALFA 10 - 20 - 30	BP-MP	BLC10
ALFA 10 - 20	AP	BLC20
ALFA 31	AP	BLC21
ALFA 10 - 20	AP-TR*	BLC25
ALFA 31	AP-TR*	BLC26
ALFA 40 - 50	BP-MP	BLC30
ALFA 40 - 50	AP	BLC40
ALFA 40 - 50	AP-TR*	BLC45

*TR Special model with downstream pressure > 2 bar

Spring range (mbar) BLC valve						
Spring Ø	BLC 10	BLC 20-21	BLC 25-26	BLC 30	BLC 40	BLC 45
MIN.	1,3	10 ÷ 90		10 ÷ 90		
	1,8	50 ÷ 250	90 ÷ 550	50 ÷ 250	90 ÷ 550	200 ÷ 900
MAX.	2,2	40 ÷ 90		40 ÷ 90		
	2,5	60 ÷ 160		60 ÷ 160		
	3	120 ÷ 280	200 ÷ 750	120 ÷ 280	200 ÷ 750	
	3,5	250 ÷ 650	600 ÷ 1200	250 ÷ 650	600 ÷ 1200	1 ÷ 3 bar
	4		2 ÷ 4,2 bar			2 ÷ 4,2 bar

OTHER PRESSURE REGULATORS

ALFA 60 - DN50 X DN50



ALFA 80 - DN80 X DN80



ALFA 100 - DN100 X DN100



All the reported data are subject to be changed without notice.

form 140303

econex

Econex s.r.l. - Via Francesco De Sanctis, 53 - I-20141 Milano
Tel. +39 0289502912 - Fax +39 028463084 - www.econex.it - info@econex.it